



TRIBUTE

Balanced Flue Convector

Model Number; PD-08-002

Fuel Effect Options:

Coal Effect

Gas Options:

NG

Control Options:

Manual Control

Remote Control

Total Control

For use on Natural Gas (G20) at a supply pressure of 20mbar in GB and IE.

**Users,
Installation & Servicing
Instructions**

MUST BE LEFT WITH THE USER

Manufacturer Contact Details:

Burley Appliances Ltd
Lands' End Way
Oakham
Rutland LE15 6RB

Tel: +44 (0)1572 725570
Fax: +44 (0)1572 724390

General E-Mail: info@magiglo.co.uk
Web Site: www.magiglo.co.uk
Technical Support: Direct Dial on **(01572) 725570** or email: **technical@magiglo.co.uk**

Burley Magiglo Document Number:
MF476.2

Revision Date:
June 2015

Copyright:
This documentation is copyrighted by Burley Appliances Ltd. ©2013.

No part of this document may be copied, photocopied or reproduced in any form or by any means without permission in writing from Burley Appliances Ltd.

Magiglo is a registered trademark of Burley Appliances Ltd.

Service Warranty:

In the unlikely event of a defect in materials or workmanship occurring within one year of purchase, Burley will arrange to repair or replace the item free of charge.

Any claims under this warranty must be made through the retailer from whom the product was purchased.

As the purchaser's contract of sale is with the retailer, Burley are unable to enter into discussions with the purchaser until the retailer has inspected any claim and deemed it to be valid.

Burley Appliances reserve the right to refuse service or make a charge for any service call, when a defect is due to installation error or misuse.

Extended warranty (if purchased) commences after the first year; please see separate registration for further information.

Appliance Details:

For future reference, please complete the following information at the time of installation.

Model and **Serial Number** details may be found on the data plate as shown.

Serial Number	
Model	
Installation Date	
Installed By	

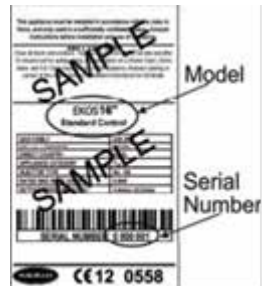

Contents

1.	GENERAL INFORMATION	1
2.	USER INSTRUCTIONS	3
2.1.	<i>Location of Pilot Burner</i>	<i>3</i>
2.2.	<i>Lighting Procedure</i>	<i>4</i>
2.2.1.	<i>Manual Control</i>	<i>5</i>
2.2.2.	<i>Lighting Procedure (Remote Control)</i>	<i>6</i>
2.2.3.	<i>Lighting Procedure (Total Control)</i>	<i>7</i>
2.3.	<i>Battery Replacement (Remote Control)</i>	<i>8</i>
2.3.1.	<i>Handset</i>	<i>8</i>
2.3.2.	<i>Receiver Unit</i>	<i>8</i>
2.4.	<i>Fitting the Trim</i>	<i>9</i>
2.5.	<i>Home Improvements</i>	<i>9</i>
2.6.	<i>Cleaning and Care Instructions</i>	<i>10</i>
2.6.1.	<i>Painted Metal Surfaces</i>	<i>10</i>
2.6.2.	<i>Brass or Chrome Surfaces</i>	<i>10</i>
3.	INSTALLATION INSTRUCTIONS	11
3.1.	<i>General Safety Requirements</i>	<i>11</i>
3.2.	<i>General Dimensions</i>	<i>11</i>
3.3.	<i>Flue Options</i>	<i>12</i>
3.4.	<i>Technical Data</i>	<i>13</i>
3.5.	<i>Appliance Location</i>	<i>14</i>
3.5.1.	<i>Mantels & Combustible Shelves</i>	<i>15</i>
3.6.	<i>Flue Terminal Location</i>	<i>16</i>
3.7.	<i>Flue Components</i>	<i>17</i>
3.8.	<i>Contents Checklist</i>	<i>17</i>
3.9.	<i>Installation Procedure</i>	<i>18</i>
3.9.1.	<i>Pre-Installation Procedure</i>	<i>18</i>
3.9.2.	<i>Preparing the Installation</i>	<i>18</i>
3.9.3.	<i>Surface Mounted Firebox Preparation</i>	<i>23</i>
3.9.4.	<i>The Gas Supply</i>	<i>26</i>
3.9.5.	<i>Fuel Effect Layouts</i>	<i>27</i>
3.9.6.	<i>Coal Effect Layout</i>	<i>28</i>
3.9.7.	<i>Fitting the Glass Panel and Frame</i>	<i>29</i>
3.9.8.	<i>Continuation of Installation - Remote Control</i>	<i>29</i>
3.9.9.	<i>Continuation of Installation - Total Control</i>	<i>30</i>
3.9.10.	<i>Commissioning</i>	<i>31</i>
3.9.11.	<i>Fitting the Trim</i>	<i>32</i>
3.9.12.	<i>Instructing the User</i>	<i>32</i>

4.	SERVICING INSTRUCTIONS	33
4.1.	<i>General Requirements</i>	33
4.1.1.	Cleaning the Fuel Effect, Fire-bed and Combustion Chamber	34
4.1.2.	Cleaning Lining Board Panels	34
4.1.3.	Care of Lining Panels.....	34
4.2.	<i>Replacing Parts</i>	35
4.2.1.	Pilot Components Removal and Replacement	35
4.2.2.	Injector Replacement	35
4.2.3.	Control Valve Replacement (Manual Control /Remote Control)	36
4.2.4.	Control Valve Replacement (Total Control)	37
4.2.5.	Motor Replacement (Remote Control Model)	38
4.2.6.	Replacing the Receiver (Total Control).....	39
4.2.7.	Programming Handset to Receiver (Total Control)	39
4.3.	<i>Installation and Operational Troubleshooting</i>	40

1. GENERAL INFORMATION

Introduction

1. This appliance is suitable for installation in GB and IE and should be installed in accordance with the rules in force.

In GB, the installation must be carried out by a Gas Safe Registered Installer. It must be carried out in accordance with the relevant requirements of the:

- Gas Safety (Installation and Use) Regulations.
- The appropriate Building Regulations either The Building Regulations, The Building Regulations (Scotland), Building Regulations (Northern Ireland).

Where no specific instructions are given, reference should be made to the relevant British Standard Code of Practice (see item 2).

In IE, the installation must be carried out by a Competent Person and installed in accordance with the current edition of I.S.813 "Domestic Gas Installations", the current Building Regulations and reference should be made to the current ETCI rules for electrical installation.

On completion of an installation in IE, it is necessary to complete a "Declaration of Conformity" to indicate compliance to I.S.813.

2. The installation of the fire should also follow the recommendations of the following current British Standards (or equivalent):

BS 6891	Pipe work Installation
BS 5440: Pts 1 & 2	Flues and Ventilation
IGE/UP/7	IGE document for gas installations in Timber Frame Buildings (Available from Institute of Gas Engineers and Managers)

3. In other EC countries equivalent rules in force must be used.
4. It is important for correct combustion of this fire that the imitation fuel is placed in accordance with the instructions given in this and associated booklets. Only approved imitation fuel, available from Burley Appliances Ltd., should be used with this appliance.
5. It is recommended that a fire guard complying with BS 8423 be fitted for the protection of young children, the elderly or infirm.
6. Ensure that curtains are not positioned above the appliance and there is at least 300mm between the sides of the appliance and any curtains.
7. Combustible shelves or materials must only be fitted above the fire in accordance with the instructions given in this and associated booklets.
8. The user is warned not to remove the glass panel or to disturb the fuel bed.
9. **If any cracks appear in the glass panel do not use the appliance until the glass panel has been replaced (by a qualified installer).**
10. Ensure that the flue terminal is always kept clear of any obstructions (e.g. shrubs, plants, objects leaning against it, etc.).
11. It is important for the fire to be serviced regularly. An annual service is recommended.

Ventilation Requirements

1. This appliance does not require any ventilation in the room where it is fitted. It is a balanced flue appliance whereby the air for combustion is drawn in from the outside and the products of combustion are evacuated to the outside through a concentric flue duct system.
2. In other EC countries equivalent rules in force must be used.

Gas Supply

1. This range of gas fires is suitable for use with Natural Gas (G20) at 20mbar supply pressure.
2. A separate means of isolating the gas supply should be provided near to the appliance to facilitate servicing. An isolation valve (with a pressure test point) has been supplied for this purpose.

Electrical Supply

Not applicable to this range of appliances.

Efficiency Declaration

The efficiency of this appliance has been measured as specified in BS EN 613:2001 and the results are 80% net. The gross calorific value of the fuel has been used for this efficiency calculation. The test data from which it has been calculated has been certified by BSI Ltd. The efficiency value may be used in the UK Government Standard Assessment Procedure (SAP) for energy rating of dwellings.

Hot Surfaces

Certain parts of this appliance get very hot during normal use. It is therefore recommended that a suitable fireguard be used for the protection of young children and the infirm. The shaded parts in **Figure 1** show the 'Working Surfaces' on the appliance.

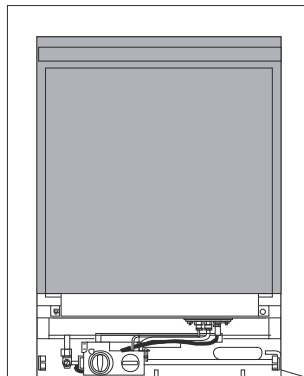

All shaded portion is
working surface

Figure 1

2. USER INSTRUCTIONS

2.1. *Location of Pilot Burner*

The pilot assembly is located at the centre of the appliance in front of the main burner.

The pilot can be viewed by looking downwards through the hole in the front ceramic between the second and third coals from the right hand side (see **Figure 2**).

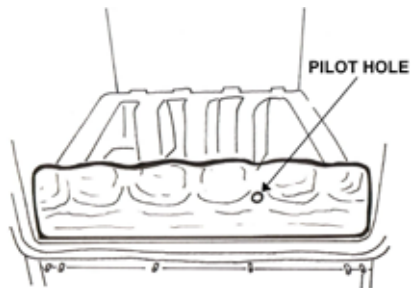







Figure 2

2.2. Lighting Procedure

Your fire will be fitted with one of the following different types of gas control valves. Identify the control system on your fire as shown and follow the appropriate operating instructions in the appropriate section.

Control Valve		Operation		Control Type
	+	Manual	=	Manual Control See Section 2.2.1 on Page 5
	+		=	Remote Control See Section 2.2.2 on Page 6
	+		=	Total Control See Sections 2.2.3 on Page 7

2.2.1. **Manual Control**

1. Whilst pushing the IGNITION KNOB in (see **Figure 3**), turn it anticlockwise to the pilot flame position as shown in **Figure 4**. During this process, the spark ignition will have operated and lit the pilot flame. On lighting the pilot flame continue to depress the ignition knob for a further 15 - 20 seconds then slowly release. The pilot flame should stay alight. If the flame goes out, repeat the procedure above to establish the pilot. Due to safety and the efficient way the fire works, it is not unusual for the pilot to stay alight only after the second or even third attempt.
2. Turn the IGNITION KNOB anticlockwise to the main flame position as shown in **Figure 5**.
3. Turn the GAS RATE ADJUSTING KNOB fully anticlockwise (until you reach the stop position) i.e. the maximum gas rate. See **Figure 6**.
4. The main burner will have cross-lit from the pilot.
5. Now the gas rate can be adjusted to the desired setting by turning the GAS RATE ADJUSTING KNOB to any position between the pre-set high and low.
6. To switch off the main burner turn the IGNITION KNOB to the 'Pilot burner only Position' as shown in **Figure 4**. The appliance may be left in this standby mode if desired.
7. To turn the pilot off turn the Ignition Knob on the control valve fully clockwise to 'A' position.

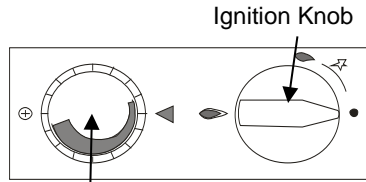

Figure 3-Off Position

Gas Rate Adjusting Knob

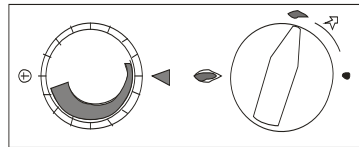

Figure 4- Pilot Burner Only

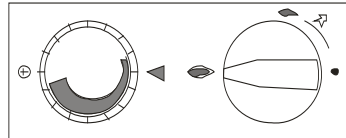

Figure 5- Main Burner Operational, but gas flow off

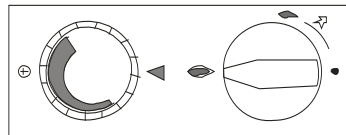

Figure 6- Main Burner Operational and Max. Gas Rate



2.2.2. Lighting Procedure (Remote Control)

1. Press the bottom button on the remote handset until clicking is heard on the valve, and the gas rate adjustment knob is at the off position.
2. With gas available at the valve press the IGNITION KNOB in and turn it anticlockwise to the pilot flame position (see **Figure 7**). A click of the piezo igniter will be heard and a spark will appear at the electrode. At the same time the gas will flow to the pilot burner and should be ignited by the spark. Repeat the procedure until the pilot flame is established.
3. Keep the knob pressed in for a further 15 - 20 seconds and slowly release it. The pilot flame should stay alight. If the flame goes out repeat the procedure above to establish the pilot. Due to safety and the efficient way the fire works, it is not unusual for the pilot to stay alight only after the second or even third attempt.
- 4.
5. **Turn the IGNITION KNOB anticlockwise to the Main Burner Operation position as shown in Figure 7.**
6. Using the HANDSET (as shown in **Figure 8**) press and hold **both the top and the small button together** until the main burner goes to full rate and clicking can be heard from the valve. During this process the main burner will ignite from the pilot.
7. By pressing the two buttons together (to increase the gas rate) and the lower button only (to decrease the gas rate) the valve can be manipulated to select the desired gas rate between maximum and minimum. By pressing the buttons in short bursts you will be able to adjust the gas rate in small steps.
8. To turn the fire off, continuously press the lower button until the flame dies down and clicks can be heard from the

valve. Release the button as soon as the clicks are heard.

9. The fire can safely be left in this position at all times, however to prevent unauthorised or accidental use (say by children) it is recommended to turn the IGNITION KNOB to the pilot flame position by turning it 90 degrees clockwise. To turn the pilot off, turn the IGNITION KNOB fully clockwise.



NOTE: The clicking sound made by the valve is the operation of the valve clutch, and indicates either maximum or minimum positions.

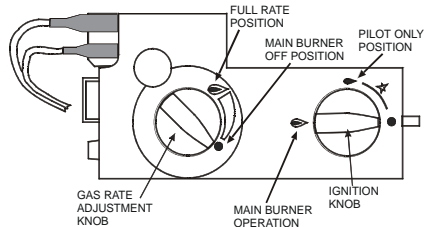

Figure 7 – Gas Valve

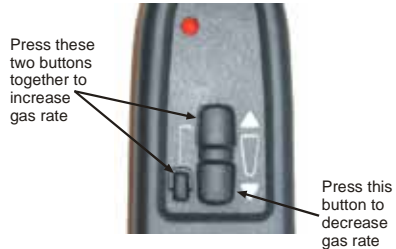



Figure 8 - Handset Operation

2.2.3. Lighting Procedure (Total Control)

1. Ensure that gas is available at the valve and the ON/OFF switch in the ON position (-). (See **Figure 9**)
8. To **turn off** the main burner and the pilot press the 'OFF' button on the hand set.

2. Simultaneously press and hold the  (red circle) and  (large flame) buttons until a short acoustic signal confirms the start sequence has begun, then release the buttons (see **Figure 10**).

3. The pilot flame should stay alight. If the flame goes out repeat the procedure above to establish the pilot. Due to safety and the efficient way the fire works, it is not unusual for the pilot to stay alight only after the second or even third attempt.

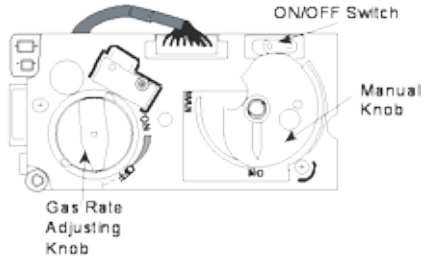







Figure 9

4. Continuing signals confirm the ignition is in process. **Once the pilot is lit the gas rate adjusting knob automatically turns to high gas rate.** The main burner cross-lights from the pilot.

5. To adjust the gas rate to desired setting press the  (large flame) to increase the flame height or  (small flame) to decrease the flame height on the handset (see **Figure 10**).

6. For fine adjustment tap the  or  buttons.

7. To leave the burner in the **standby mode** press the  (small flame) until the main burner goes out. In the standby mode the pilot stays alight.

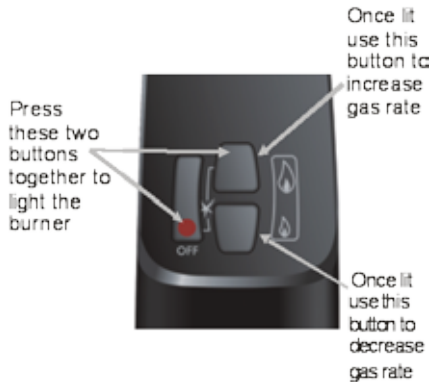

Figure 10

2.3. Battery Replacement (Remote Control)

2.3.1. Handset

1. On the reverse of the handset remove the battery cover by pressing down at the top of the cover and sliding down.
2. Remove and unclip the old battery and replace with a new PP3 9V battery.
3. Replace the cover. - **Figure 11**



Figure 11

2.3.2. Receiver Unit

1. Remove the receiver unit from under the fire burner (or from wherever positioned if mounted remotely) and remove the battery compartment cover (see **Figure 12**).
2. Replace the old batteries with new ones, ensuring they are inserted in the correct polarity.
3. Replace the cover on the receiver unit, ensuring that it is securely closed.
4. Return the receiver unit to its original mounting position.



Figure 12



CAUTION: With the exception of battery replacement, the battery holder must be located within the heat shield **at all times**.

Note: For programming a replacement remote control handset to the receiver. Refer to P.40 item 4.2.7.

2.4. Fitting the Trim

1. Most trims are coated with a protective film. This must be removed by peeling off before fitting the trim.
2. Hook the outlet fascia plate at the top of the glass frame (see **Figure 13**).
3. The trim is held on by four magnets. These will either be attached to the trim or supplied loose in a separate envelope. Attach them to the four brackets on the side flanges of the fire as in **Figure 14**.
4. Offer the trim onto the flange of the firebox. The magnets will hold the trim in position.
5. Centralise the trim as necessary.

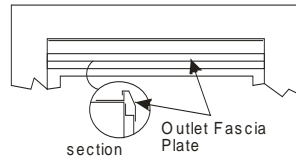

Figure 13

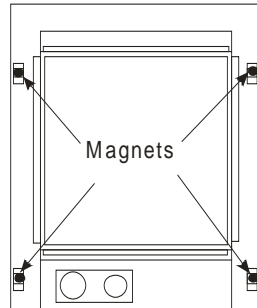

Figure 14

2.5. Home Improvements

NOTICE: Discolouration of wall surfaces



Generally, heating appliances will create warm air convection currents that will transfer heat to any wall surface against which they are located. Some soft furnishings (including blown vinyl wallpapers) may not be suitable for use where they are likely to encounter temperatures above the normal room level. For this reason, the manufacturer's advice should be sought before using this type of wall covering adjacent to any heating appliance.

The likelihood of wall staining caused from convected air currents will be increased in areas where high levels of tobacco smoke or other contaminants exist.

2.6. Cleaning and Care Instructions

2.6.1. Painted Metal Surfaces

These surfaces should be dusted regularly and any marks removed with a soft damp cloth. This should be done only when the appliance is cold.

2.6.2. Brass or Chrome Surfaces

These surfaces should be cleaned with a proprietary non-abrasive metal cleaner.

Remove the trim (if fitted), the fret and the ash-pan cover before cleaning.

The trim is held in place by means of four magnets at the rear of the trim. The fret and the ash-pan cover are free standing in front of the fire.

3. INSTALLATION INSTRUCTIONS

Before installation, ensure that the local distribution conditions (identification of the type of gas and pressure) and the adjustment of the appliance are compatible)

3.1. General Safety Requirements

Before commencing installation, ensure that the intended installation will comply with details in **General Information** on Page 1.

The installation of the fire should follow the recommendations of the following current British Standards (or equivalent):



BS 6891

BS 5440: Pts 1 & 2

IGE/UP/7

Pipe work Installation

Flues and Ventilation

IGE document for gas installations in Timber Frame Buildings (Available from Institute of Gas Engineers and Managers)

Combustible shelves or materials must only be fitted above the fire as described later in this section.

Ensure that curtains are not positioned above the appliance and there is at least 300mm between the sides of the appliance and any curtains.

3.2. General Dimensions

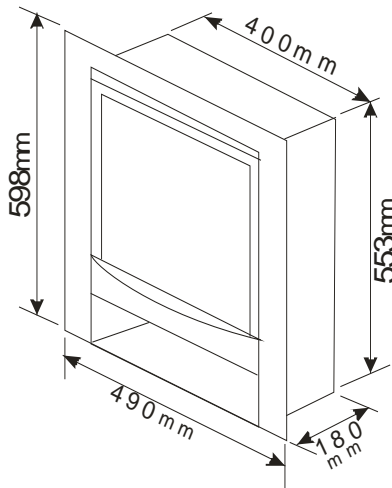

Figure 15

3.3. Flue Options

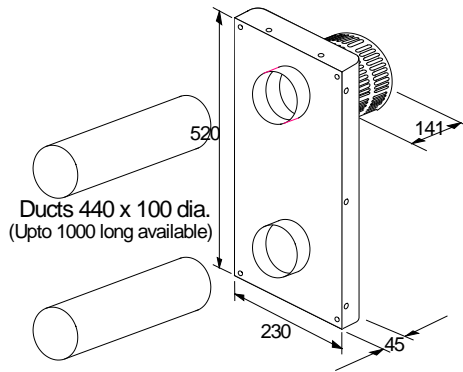

Figure 16

The horizontal length is measured from the rear of the appliance outer flange to the external face of an external wall.

3.4. Technical Data

	Natural Gas (G20)
Nominal maximum heat input (hot)	4.0 kW (gross)
Nominal minimum heat input (hot)	2.3 kW (gross)
Setting pressures (cold) Max	7.0 ±0.5 mbar
Setting pressures (cold) Min	2.0 ± 0.2 mbar
Gas Rate	0.36 m ³ /h
Injector Size Multiport	7 x 0.77mmØ
Gas Inlet Connection	8 mm Compression
Pilot	Polidoro 440.0333.11
Pilot Injector	2 x 0.25mm holes
Efficiency	Class I
Weighted NOx	Class 4
Max / Min length of flue tube	1000 / 150mm

Table 1

3.5. Appliance Location

The appliance is designed to be fitted through a non-combustible back panel and to be inset into a cavity wall. Alternatively the appliance may be fitted into a false chimney breast, a deep rebated fire surround or a defunct fireplace sited on an outside wall. The appliance may be sited at floor level or as a raised 'hole in the wall' installation. If sited in an 'hole in the wall' installation provision must be made to stand the decorative fret upon.

In all installations we recommend a non-combustible back panel is used. We do not recommend installing the appliance against a plastered wall without a back panel. The fire must be fitted on a flat non-combustible base. In addition a non-combustible hearth with minimum dimensions shown in figures below should be provided in front of the fireplace opening where relevant. This is required to protect combustible floor coverings from radiant heat from the fire. If the appliance is to be installed with its base more than 100mm above floor level the hearth projection in front of the appliance may be reduced to the minimum required to support the decorative fret (75mm).

Floor Level and Raised Fireplace Openings

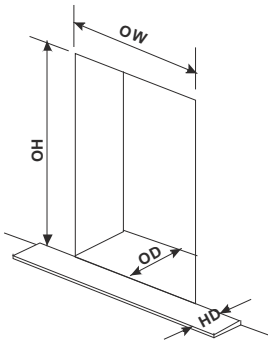

Figure 17-Floor Level Opening

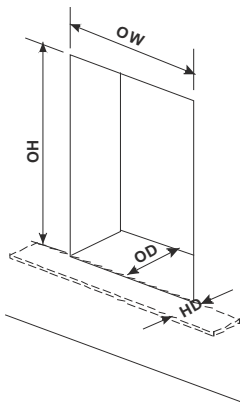
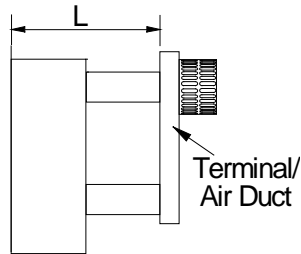

Figure 18 – Raised Level Opening

Floor Level and raised Level Openings	
OH	560mm
OW	420mm
OD	200mm
HD	Enough to support decorative fret (75mm)

Table 2



L min - 320mm
L max - 1170mm

Figure 19

3.5.1. ***Mantels & Combustible Shelves***

1. Shelves or mantels made from combustible materials should not be placed closer than 300mm above the appliance.

Light coloured and resin mantels may discolour in time. The temperature rating of the surround should be checked before use. We recommend a fire surround with a minimum 150 degrees Celsius rating.

3.6. Flue Terminal Location

The minimum acceptable dimensions from the flue terminal to obstructions and ventilating openings are shown in **Table 3** and **Figure 20**.

Dimension	Terminal Position	Value mm
A	Directly below an opening, air brick, opening windows, etc.	300
B	Above an opening, air brick, opening window, etc.	300
C	Horizontally to an opening, air brick, opening window, etc.	300
D	Below gutters, soil pipes or drain pipes	300
E	Below eaves	300
F	Below balconies or car port roof	600
G	From a vertical drain pipe or soil pipe	300
H	From an internal or external corner	600
I	Above ground, roof or balcony level	300
J	From a surface facing the terminal	600
K	From a terminal facing a terminal	600
L	From an opening in the car port (e.g. door, window) into the dwelling	1200
M	Vertically from a terminal on the same wall	1500
N	Horizontally from a terminal on the same wall	300

Table 3

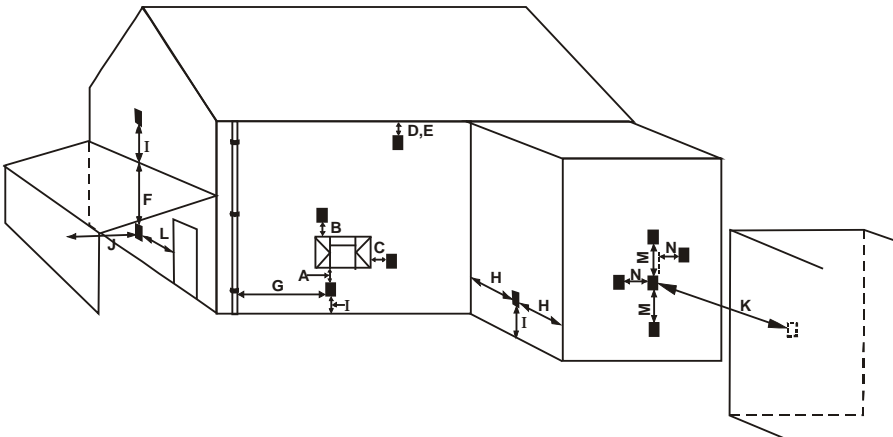

Figure 20

3.7. Flue Components

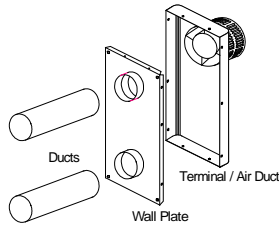

Figure 21

3.8. Contents Checklist

Before proceeding with installation of the fire check the contents as follows:
Basic Kit (Applicable to all control options)

Carton 1

Quantity	Item
1 1 bag	Gas Fire Containing documentation, a length of sealing strip, cable fixing kit, Outlet Fascia Plate, isolation valve, Infill plate

Carton 2

Quantity	Item
1 box	Imitation Coal or Log Pack, Front and Rear Ceramic Matrices, Fire Cement.
1 box	Standard flue kit containing a 2 x 440mm lengths of 100mmØ ducts, Snorkel Air Box, Terminal Guard

Carton 3

Quantity	Item
1	Outer Fascia Frame and Magnets

OR

1	Brass or Decorative Trim
4	Magnets
+ Carton 5	
1	Fire Fret & Ashpan Cover

Additional Items for Remote Control & Total Control Models

Quantity	Item
1box	Remote Control Handset and Receiver, 4 off AA Batteries, 1 off PP3 (9V) Battery

3.9. Installation Procedure



Before commencing installation, ensure that the intended installation will comply with details in **General Information** on Page 1.

Carefully unpack the contents of the carton and check them against the checklist given on the previous page.

3.9.1. Pre-Installation Procedure

Appliance

1. Unpack the appliance from its carton.
2. Remove the 14 glass frame retaining nuts (see **Figure 22**) and lift off the glass frame. Place in a safe place.
3. Apply the sealing tape around the rear edge of the flange on the appliance.
4. Unpack the cables from the cable fixing kit and feed the end into the holes in the two tabs at the rear top of the appliance (see **Figure 23**)

The appliance is now ready for installation.

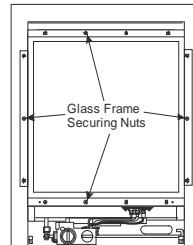

Figure 22

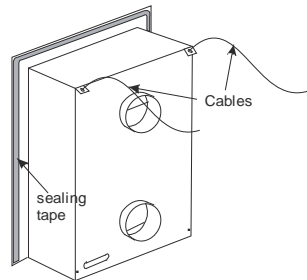

Figure 23

3.9.2. Preparing the Installation

General Notes

1. Attempt to keep the recess and any hole sizes as close as possible to the minimum dimensions. This will keep the installation tidy without the need for excessive sealing afterwards.
2. Ensure any damp course, electrical wiring and any pipe work within the wall is not going to be affected by the installation.
3. Any gas pipe concealed in the wall, floor or cavity must be continuous and enclosed within a gas tight sleeve. (See current Gas Safety (Installation & Use) Regulations:.)
4. Ensure that the chosen position for the appliance will comply with the requirements detailed in **Section 3.5**
5. Having decided the appropriate installation type, e.g. recessed or surface mount, proceed to the appropriate following section.

3.9.2. Installation Procedure for Recessed Installation

On the inside wall:

1. Measure the height of the hearth (in the case of a raised installation ascertain the height of the top surface of the hearth) and mark a horizontal line on the wall at the same height.
2. Above the hearth level draw a rectangle to the dimensions of the recess as detailed in **Figure 17** or **Figure 18**. Note that a lintel will be required above the recess of the fire to support the inner wall. If in doubt seek expert building advice.
3. Cut the recess in the inner wall ensuring that when the non combustible backing panel/slips is in place there is sufficient depth to accommodate the firebox.
4. Screed the floor of the recess to the level of the hearth to allow for accurate fitting of the firebox and flue and air supply ducts.
5. Mark a vertical line on the outer leaf of the cavity wall down the centre line. From the screeded floor measure up and mark 125mm and 470mm. At these two points drill 125mmØ holes with a core drill (see **Figure 24**).
6. Mark out, drill, plug and fit the four eye screws onto the rear wall of the fireplace opening as shown in **Figure 24**.
7. Ensure that any cavity wall insulation or other combustible materials within the installation are removed and replaced with Rockwool or equivalent material.
8. At this point install the hearth, back panel and mantel if one is to be used.
9. Bring the gas supply into the recess and position so it lines up with the gas entry port in the rear of the convector box. This is situated 105 - 165mm to the right of centre and 40mm above the screeded floor of the recess (see **Figure 24**).

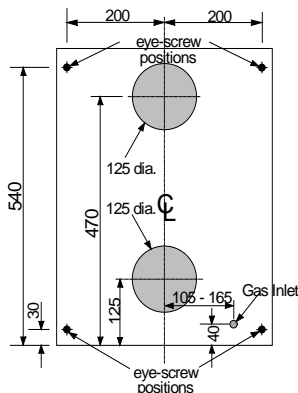
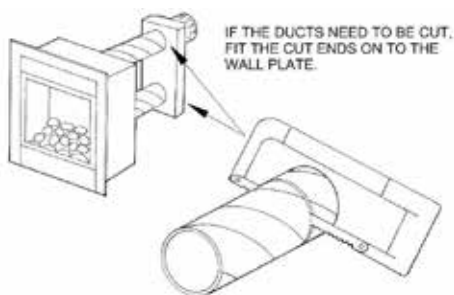

Figure 24

10. Measure the distance **L** between the face side of the back panel and the outside surface of the outer leaf through the drilled Ø125mm holes (see Figure 30). From this figure **deduct 170mm**. Cut two pieces of Ø100mm ducts to the new figure and deburr the ends. (Note; Two 440mm lengths of 100mmØ ducts are supplied which is sufficient for most inset installations. Extra lengths of ducts up to 1000mm can be supplied. (This is also the maximum length of ducts that is permitted to be used.)



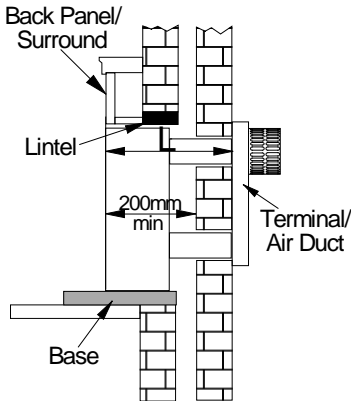

Figure 25

11. **Important!** The Fire cement supplied must be applied around each of the duct spigots on the rear of the appliance to guarantee a seal. Do not use silicone based sealants anywhere around the firebox.
12. Push the two lengths of ducts previously cut on to the duct spigots. Make sure the ducts are pushed fully home up to the firebox.
13. Position the firebox complete with ducts attached centrally into the fire opening. Thread the cables through the eye-screws. With the firebox placed close to the fireplace opening feed the two cables through the matching eye screws (left cable through left hand set of eyelets and the same for right hand cable) and then back into the holes at the bottom rear of the firebox (see

Figure 26). Remove the grommet from the gas inlet slot on the firebox to allow for gas pipe to come through. Whilst pulling the cables, push the firebox gently into the opening (ensuring that the gas pipe emerges from the rear slot) until the flange of the firebox abuts the fire surround (or the wall).

Feed each bare cable end into the hole in the brackets on the base of the firebox and in turn through the hole at the threaded end of the cable tensioning screw. (See **Figure 27**).

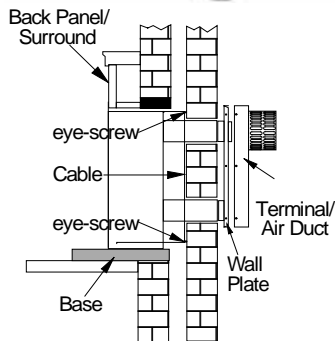
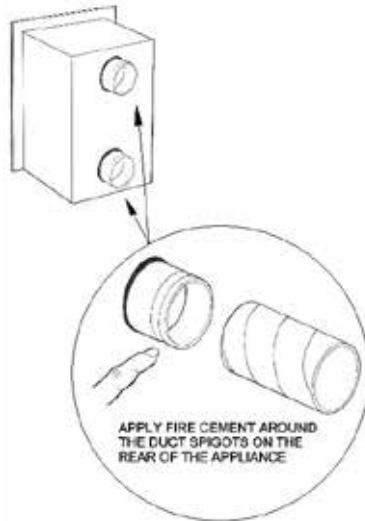

Figure 26

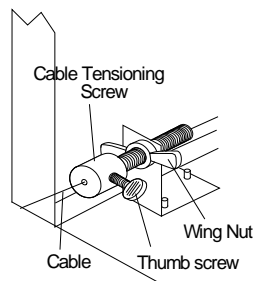
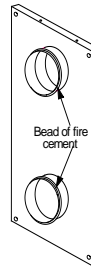

Figure 27

14. Slide each of the tensioning screws all the way onto the cable and through the hole in the bracket.
15. Whilst holding the cable tensioning screw in the bracket, pull the cable taught and without releasing the tension tighten the thumb screw firmly. To further tighten the cables, screw the wing nuts clockwise.
16. Roll up the excess cable and tuck it away. **DO NOT CUT** the excess cable.



Wall Plate

Figure 28

On the Outside Wall

1. Unscrew the outer cover and terminal from the wall plate.
2. Engage the duct spigots with the two ducts from the rear of the appliance. The duct spigot on the outside of the wall plate should be uppermost.
3. Mark the four fixing positions onto the wall and remove the wall plate. Drill and plug the marked positions. Do not use Silicone to the plate.
4. Apply fire cement around the two duct spigots on the inside of the wall plate (see Figure 28)
5. Engage the duct spigots with the two tubes from the rear of the appliance. The duct spigot on the outside of the wall plate should be uppermost. Push the wall plate fully home and fix in position with appropriate screws. Screw the outer cover and terminal back onto the wall plate. Apply a bead of mastic around the periphery of the wall plate to prevent water ingress.
6. If the centre of the terminal is within 2 metres of the ground or a balcony the terminal guard must be fitted.
7. For assembly and fitting of the terminal guard refer to figure 16 and figure 21.
8. Fold up the four sides of the cage to 90 degrees, locking the corners with the tabs and slots as you go. Using some pliers from inside the cage, to fold over the end of the locking tab at 90 degrees to make them very tight and secure. (see figure 29)
9. Fit the guard over the top half of the terminal and secure to the wall using the four fixing points. (see figure 30)

Figure 29

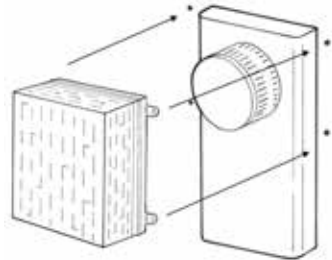
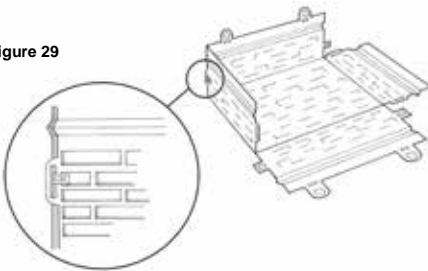

Figure 30

Inside again:

1. Cut a cross-slot in the rubber grommet and push it on to the gas pipe to seal the gas inlet slot on the firebox.
2. Make the gas connection to the appliance using the isolating valve as described in the Gas Supply section.
3. Place the front and rear burner ceramics and lay the coals, pebbles or logs as described in the Fuel Effects Layout Section.
4. Secure the glass door as described in the Glass Door Section.
5. Proceed to appropriate section depending on the control option fitted on the appliance.

3.9.3. Surface Mounted Firebox Preparation

On the inside wall:

1. Measure the height of the hearth (in the case of a raised installation ascertain the height of the top surface of the hearth) and mark a horizontal line on the wall at the same height.
2. Mark a vertical line on the wall on the centre line of the installation. From the horizontal line measure up and mark 125mm and 470mm. At these two points drill 125mm \varnothing holes with a core drill (see **Figure 31**).
3. Ensure that any loose cavity wall insulation is replaced with Rockwool or equivalent material.
4. Erect the false chimney breast or deep rebate fire surround. Any items made of combustible materials shall be suitably protected with 12mm thick 'Superlux' or equivalent material and at least 50mm thickness Rockwool or equivalent material inserted between the top, back and sides of the appliance and the superlux. If the appliance is to be installed on a wall made of combustible materials the flue must be encased in a metal so that there is at least 50mm space between the flue and the duct. This space must be filled with mineral wool.
5. If the enclosure is to be plastered it must be allowed to dry before proceeding. The plaster must be completely dry before any prolonged use of the appliance.
6. Any combustible material to the rear of the firebox, on the inside wall and within the false surround shall be removed.
7. Mark out, drill, plug and fit the four eye screws onto the rear wall of the fireplace opening as shown in **Figure 31**.
8. At this point install the hearth, back panel and mantel if one is to be used.
9. Bring the gas supply into the recess and position so it lines up with the gas entry port in the rear of the convector box. This is situated 105 - 165mm to the left of

centre and 40mm above the floor of the recess (see **Figure 31**).

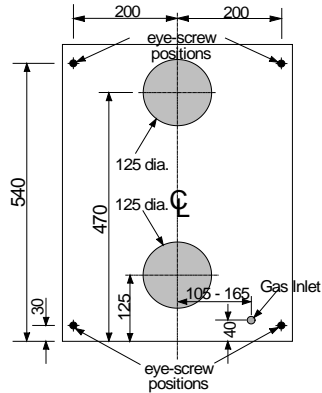
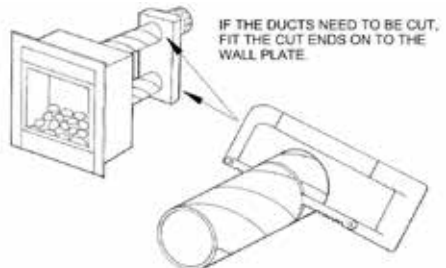

Figure 31

10. Measure the distance **L** between the face side of the back panel and the outside surface of the outer leaf through the drilled \varnothing 125mm holes (see **Figure 32**). From this figure **deduct 170mm**. Cut two pieces of \varnothing 100mm duct to the new figure and deburr the ends. (Note; Two 440mm lengths of 100mm \varnothing duct are supplied which is sufficient for most inset installations. Extra lengths of duct up to 1000mm can be supplied. (This is also the maximum length of duct that is permitted to be used.)



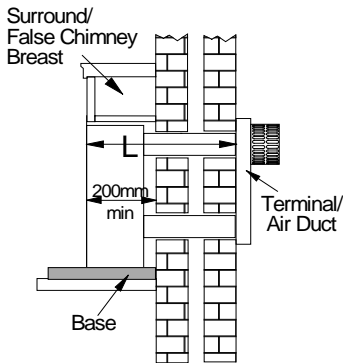
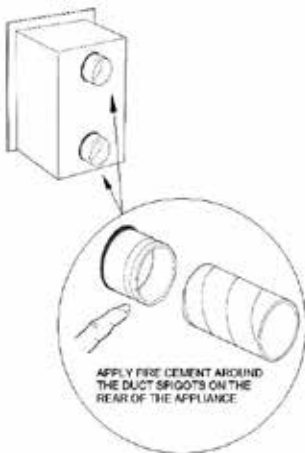

Figure 32

11. Apply the fire cement supplied around each of the duct spigots on the rear of the appliance.
12. Push the two lengths of duct previously cut on to the duct spigots. Make sure the ducts are pushed fully home up to the firebox.
13. Position the firebox complete with ducts attached centrally into the fire opening. Thread the cables through the eye-screws. With the firebox placed close to the fireplace opening feed the two cables

through the matching eye screws (left cable through left hand set of eyelets and the same for right hand cable) and then back into the holes at the bottom rear of the firebox (see **Figure 32**). Remove the grommet from the gas inlet slot on the firebox to allow for gas pipe to come through. Whilst pulling the cables, push the firebox gently into the opening (ensuring that the gas pipe emerges from the rear slot) until the flange of the firebox abuts the fire surround (or the wall).

14. Feed each bare cable end into the hole in the brackets on the base of the firebox and in turn through the hole at the threaded end of the cable tensioning screw. (See **Figure 27**)
15. Slide each of the tensioning screws all the way onto the cable and through the hole in the bracket.
16. Whilst holding the cable tensioning screw in the bracket pull the cable taut and without releasing the tension tighten the thumb screw firmly. To further tighten the cables, screw the wing nuts clockwise.
17. Roll up the excess cable and tuck it away. Do **NOT CUT** the excess cable.



On the Outside Wall:

1. Unscrew the outer cover and terminal from the snorkel wall plate.
2. Engage the duct spigots with the two ducts from the rear of the appliance. **The duct spigot on the outside of the wall plate should be uppermost.**
3. Mark the four fixing positions onto the wall and remove the wall plate. Drill and plug the marked positions.
4. Apply fire cement around the two duct spigots on the inside of the wall plate (see **Figure 33**).
5. Engage the duct spigots with the two ducts from the rear of the appliance. **The duct spigot on the outside of the wall plate should be uppermost.**

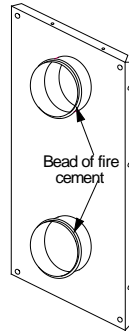

Wall Plate

Figure 33

Inside again:

1. Cut a cross-slot in the rubber grommet and push it on to the gas pipe to seal the gas inlet slot on the firebox.
2. Make the gas connection to the appliance using the isolating valve as described in the Gas Supply section.
3. Place the front and rear burner ceramics and lay the coals, pebbles or logs as described in the Fuel Effects Layout Section
4. Secure the glass door as described in the Glass Door Section.
5. If manual control option is fitted proceed to commission the appliance.
6. For other control options proceed to appropriate section to continue with installation.

3.9.4. *The Gas Supply*

1. The gas supply can be fed into the firebox from the left hand rear. Care should be taken to sleeve the pipe when passing through masonry.
2. Make an appropriate slit in the rubber grommet and feed the gas supply pipe through it. Seal gas inlet slot with the grommet.
3. An isolating valve (with a pressure test point) has been supplied with this fire to facilitate isolation of the fire during servicing. The gas supply to the fire must be carried out using rigid or semi-rigid tubing.
4. Connect the outlet of the isolating valve to the inlet of the control valve on the fire tray. The outlet on the isolating valve is the one nearest to the pressure test point.

3.9.5. *Fuel Effect Layouts*



Due to the nature of this appliance, the Fuel effect layout should only be carried out by a Gas Safe Registered Installer in GB or a Competent Person (engineer) in IE and other EC countries.

RCF Advice:

This product may use Components (Fuel Effects & Ceramic backs) containing Refractory Ceramic Fibres (RCF), which are man-made vitreous silicate fibres. Excessive exposure to this material may cause irritation to eyes, skin and respiratory tract.



Therefore during installation and servicing we recommend that you use a HEPA filtered vacuum to remove any dust and soot accumulated in and around the fire before and after working on the fire, to ensure that the release of fibres from these RCF articles is kept to a minimum.

We recommend that you should follow the normal hygiene rules of not smoking, eating or drinking in the work area.

When replacing Components containing Refractory Ceramic Fibres (RCF), we recommend that the replaced items are not broken up, but are sealed within heavy duty polythene bags, and clearly labelled as RCF waste. RCF waste may be disposed of in suitably licensed landfill sites.



WARNING: Do not touch the fire when it is alight. The fire will remain very hot for a while after extinguishing.

3.9.6. **Coal Effect Layout**

The fire is supplied with a set of ceramic fuel set as follows:

	Qty
Front Ceramic	1
Rear Ceramic	1
Moulded Matrix	1

Proceed with the layout as follows:

1. Position the rear burner ceramic in position behind the rear burner flange, as shown in **Figure 34**.
2. Place the front burner ceramic in its support in front of the burner as in **Figure 35**. Manipulate the rear ceramic so that the front ceramic slides in easily.
3. Place the moulded coal matrix on top of the base ceramic so that the front rests on top of the front ceramic. Manipulate it so that the contour of the underside of the coal matrix corresponds to the top of the front ceramic.



Figure 34 – Rear Ceramic

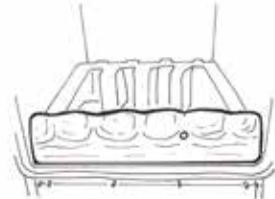

Figure 35 – Front Ceramic

3.9.7. *Fitting the Glass Panel and Frame*

1. Refit the glass panel/frame and fully secure in position using the previously removed nuts. To ensure a good seal tighten the nuts in a diagonal sequence a few turns at a time
2. Fully tighten all the nuts.
3. Fit the infill plate (See Figure 48). If required attach fret in fills with magnets provided.
4. **Do not** fit with Harmony trim or the Accord range of trims

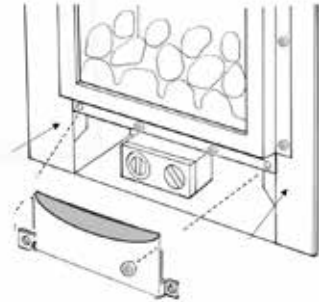

Figure 48

3.9.8. *Continuation of Installation - Remote Control*

1. Unpack the box containing the Receiver and the Hand Set.
2. Fit four AA (1.5V) batteries into the receiver unit and the PP3 (9V) battery into the transmitter (hand set).
3. Feed the cable from the receiver unit to the spade terminals on the control valve, keeping the cable clear of the underside of the combustion chamber. The cable connectors must be matched to the appropriately sized spade connector (see **Figure 36**).
4. Test the operation of the drive motor using the hand set as per Users Instructions (**Section 2.2.2 - Lighting Procedure (Remote Control)** on **page 6**).
5. Fold the heat shield as per folding instructions supplied and position it over the receiver.
6. Proceed to Section **3.9.10** to commission the installation.

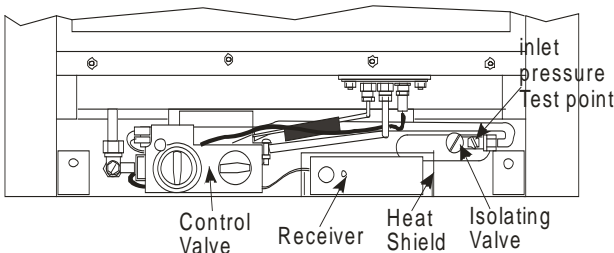

Figure 36

3.9.9. *Continuation of Installation - Total Control*

1. Unpack the box containing the Receiver and the Hand Set.
2. Fit four AA (1.5V) batteries into the receiver unit and the PP3 (9V) battery into the transmitter (hand set).
3. Connect the cables from the valve to the receiver as shown in **Figure 37** keeping the cables clear of the underside of the tray. Does not force the valve cable plug when inserting into the receiver – it only fits one way.
4. Connect the HT lead to the receiver
5. Test the operation of the drive motor using the hand set as per Users Instructions (**Section 2.2.3 - Lighting Procedure (Total Control)**) on page 7).
6. Fold the heat shield as per folding instructions supplied and position it over the receiver.

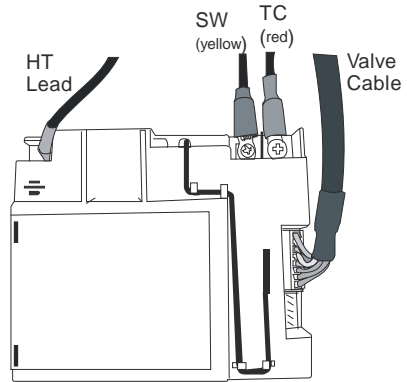

Figure 37

3.9.10. **Commissioning**

1. Turn on the gas supply to the fire and purge the gas line. Check all the gas joints for gas soundness.
2. Connect a pressure gauge to the pressure test point on the isolating valve.
3. Ignite the pilot in accordance with the User Instructions.
4. Set the controls to give full gas rate at the main burner. Check that the main burner cross lights smoothly.
5. Ensure that the pressure at the pressure test point is 20 ± 1.0 mbar for natural gas or 37 ± 1.0 mbar for Propane.
6. If the correct pressure cannot be achieved, then some potential causes of low pressure are:
 - a) Supply pipes are not of large enough diameter.
 - b) The supply pipes are kinked, blocked or partially blocked.
 - c) Restriction at the appliance isolation valve.
7. Set the control to the low rate position (small flame image) and ensure that the flames reduce in size.
8. Turn the fire off.
9. Replace the screw in the pressure test point.

Note: On short lengths of duct, the fire will be more prone to the effects of high wind. The flames may 'pulse' quite high and then low depending on the outside pressure on the terminal. This is normal on short lengths of duct and should not cause concern.

3.9.11. *Fitting the Trim*

If the appliance is installed at floor level a three sided trim will be supplied with the appliance. Follow instructions in Users section to fit the trim

3.9.12. *Instructing the User*

The installer must hand over these instructions to the user and explain how to operate this fire, stressing the importance of having the fire checked and serviced regularly. An annual service is recommended.



It is mandatory as part of the gas installation that the installer instructs the user on the correct operation and care of their appliance.

Important Note:



The first time your appliance reaches operating temperature you will smell the paint on the outside of the appliance curing. This is normal. We recommend that you leave some of the windows in the home open for a few hours during the first time the fire is run.

Instruct the user to run the fire on full for at least 5 hours continually with the doors and windows open to allow the appliance to get hot to cure the paint and seals.

Running for just a short period will not be enough to get the fire to a temperature that cures the paint and the appliance will continue to smell.

4. SERVICING INSTRUCTIONS

4.1. General Requirements

All repairs and servicing must be carried out by a qualified registered gas installer (e.g. member of Gas Safe Register in GB) in accordance with the current Gas Safety (Installation and Use) Regulations and these instructions.

Before any servicing is carried out ensure that the gas and electric supply (where applicable) are turned off.

Always check for gas soundness after dismantling or exchange procedures.



CAUTION: Ensure that the appliance is off (including the pilot light) and has completely cooled (off for at least 2 hours) before carrying out any cleaning or maintenance.



RCF Advice:

This product may use Components (Coals, Pebbles & Ceramic backs) containing Refractory Ceramic Fibres (RCF), which are man-made vitreous silicate fibres. Excessive exposure to this material may cause irritation to eyes, skin and respiratory tract.

Therefore during installation and servicing we recommend that you use a HEPA filtered vacuum to remove any dust and soot accumulated in and around the fire before and after working on the fire, to ensure that the release of fibres from these RCF articles is kept to a minimum.

We recommend that you should follow the normal hygiene rules of not smoking, eating or drinking in the work area.

When replacing Components containing Refractory Ceramic Fibres (RCF), we recommend that the replaced items are not broken up, but are sealed within heavy duty polythene bags, and clearly labelled as RCF waste. RCF waste may be disposed of in suitably licensed landfill sites.

4.1.1. ***Cleaning the Fuel Effect, Fire-bed and Combustion Chamber***

1. Remove the infill plate and the glass door panel and place it in a safe place.
2. Carefully remove all the fuel bed ceramics from the fire. Lift out the front and rear ceramics. Any debris/dust or soot can be brushed off using a **soft brush**.
3. Remove the two screws securing the burner and gently lift it out of the appliance. Clean the burner slot with a brush and check that the venturi is clear.
4. Check that the electrode sparks across the gap when the ignition knob is operated.
5. Use a vacuum cleaner to remove any fluff or lint on the base of the combustion chamber.
6. Refit the burner and secure in place using the previously removed screws.
7. Replace the front and rear ceramics and relay the fuel bed as described in the appropriate fuel bed layout sections.
8. Refit the glass/frame and secure in place using the previously removed nuts. Refit the infill plate.
9. The flue can be inspected and cleaned by removing the terminal/ outer cover.

4.1.2. ***Cleaning Lining Board Panels***

Any soot or dust marks on the side, top or rear panels can be cleaned by lightly dusting them with a very soft brush.



NOTE: Any attempt to clean the lining panels using an alternative method, will result in irreparable damage leading to a replacement being required.

4.1.3. ***Care of Lining Panels***

The lining panels on this appliance must NOT be sprayed with any type of solvent-based high temperature paint.

The very high temperatures produced within the appliance will cause the paint to bubble and/or burn off rendering the fireback looking unsightly.

Minor surface scuffs may be treated using a water based touch up stain available at Burley fire retailers.



Extreme care should be taken when handling and installing products containing ceramic fibre board, so as not to cause damage.

4.2. Replacing Parts

For any spare parts that are required, please contact either your supplier or the manufacturer directly. You will need the model name i.e. model number, the gas type, the type of control and serial number.

Only approved parts should be used.

Isolate the gas supply at the isolating valve under the fire before proceeding.

4.2.1. Pilot Components Removal and Replacement

1. Follow procedures 1 - 2 in the **Section 4.1.1** to gain access to the pilot assembly.
 2. Pull off the electrode spark lead, loosen and remove the electrode clamp nut and remove the electrode. **Always remove the electrode when working on the pilot to prevent damage.**
 3. Loosen the thermocouple clamp nut and draw the thermocouple downwards. Due to heat and age the nut may have to be fully undone before the thermocouple can be removed.
 4. Unscrew the 4mm pilot gas supply tube nut and ease the tube downwards. The pilot injector will probably fall out or it may have to be dislodged with a piece of wire.
 5. To change the thermocouple the thermocouple nut will have to be unscrewed from the rear of the control valve (this requires removal of the control valve).
 6. The pilot burner can now be removed by unscrewing the two screws and nuts on either end of the burner. The spacer should come away at the same time.
- NOTE:** If at any time the pilot assembly is removed / replaced the spacer should be replaced as well.
7. Before replacing the pilot burner check the condition of its gasket. Replace if necessary.

4.2.2. Injector Replacement

1. Remove the glass door panel, the fuel bed components and the front and rear ceramics.
2. Lift out the top lining board followed by the two sides and the back.
3. Remove the main burner.
4. Carefully unscrew the injector tube nut. Unscrew the two screws securing the burner/injector mounting bracket. Lift away the burner support bracket. Unscrew the injector securing nut.
5. Remove the injector and replace it with the new one and secure in position with the injector securing nut (do not fully tighten it at this point. Refit the injector tube nut.
6. Secure the burner/injector mounting bracket using the securing screws.
7. Tighten the injector tube nut **ensuring that the injector mounting bracket does not distort**. Tighten the injector securing nut.
8. Replace the burner support bracket followed by the other components.

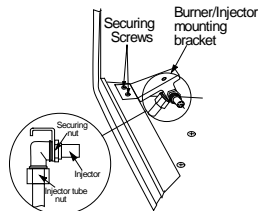

Figure 38

4.2.3. **Control Valve Replacement (Manual Control /Remote Control)**

Referring to **Figure 39** and **Figure 40**:

1. Remove the glass door panel and the ceramic fuel bed components.
2. Remove the main burner after removing the securing screws and lifting up the right hand side of the burner (see **Figure 39**).
3. After isolating the gas supply undo the nut securing the gas supply isolating valve to the gas inlet tubing to the valve (**Detail A**).
4. Remove the cable connection (**Detail B**) from the motor and remove the receiver (Remote control Model only).
5. Undo the nuts on the compression elbow underneath the injector and disengage the tubing (**Detail C**).
6. Remove the spark electrode from the pilot burner. Unscrew the tube nut below the pilot burner. Pull downwards and disengage the tube. The pilot injector will probably fall out. Keep it in a safe place. (**Detail D**).
7. Loosen the thermocouple clamp nut (**Detail E**) and pull the thermocouple clear of the pilot burner.
8. Undo the two self-tapping screws holding the valve bracket from inside the appliance.
9. Pull out the valve. Disconnect the thermocouple from the rear of the valve.
10. Remove the valve cover by removing the securing screw and levering out the cover through the slot on the opposite side using a small screw driver.
11. Remove the old valve from the mounting bracket and replace with new one.
12. Transfer all the tubing on the old valve to the new one ensuring that the tubing

positions are approximately same as before. Tighten all connections.

13. Reconnect the thermocouple to the rear of the valve.
14. Refit the valve in reverse order.
15. Refit the HT lead and remake all the gas connections.
16. Refit the rest of the components in reverse order.

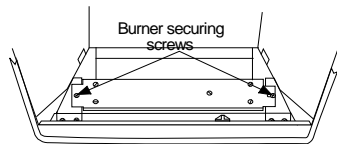

Figure 39

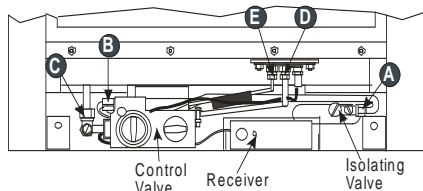

Figure 40

4.2.4. Control Valve Replacement (Total Control)

1. Pull out the receiver from under the fire and remove the batteries.
2. Carefully pull out the valve cable (see **Figure 41**).
3. Disconnect the SW cable (with yellow sleeve) from the receiver (See **Figure 41**).
4. Remove the glass door panel, the fuel bed components and the front and rear ceramics.
5. Remove the main burner after removing the securing screws (see **Figure 39**).
6. Undo the nut securing the gas supply isolating elbow to the gas inlet tubing to the valve (Detail A in **Figure 40**).
7. Undo the nuts on the compression elbow underneath the injector and disengage the tubing (Detail C in **Figure 40**).
8. Remove the spark electrode from the pilot burner. Unscrew the tube nut below the pilot burner. Pull downwards and disengage the tube. The pilot injector will probably fall out. Keep it in a safe place (Detail D in **Figure 40**).
9. Loosen the thermocouple clamp nut and pull the thermocouple clear of the pilot burner.
10. Undo the two self-tapping screws holding the valve bracket from inside the appliance and withdraw the valve complete with the bracket.
11. Remove the thermocouple connection from the back of the valve.
12. Pull out the TC cable (with red sleeve) from the interrupter block (see **Figure 42**).
13. Transfer all the tubing on the old valve to the new one ensuring that the tubing positions are approximately same as before. Tighten all connections.
14. Remake all the connections at the rear of the valve and the receiver in reverse order.
15. Refit the valve in reverse order.
16. Refit the HT lead and remake all the gas connections.
17. Refit the rest of the components in reverse order.

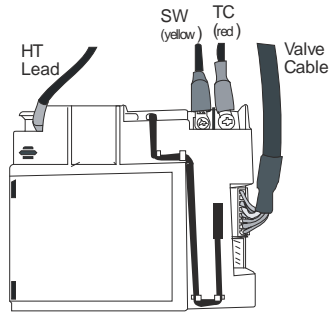

Figure 41

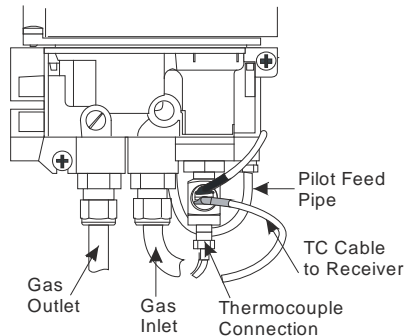

Figure 42

4.2.5. **Motor Replacement (Remote Control Model)**

The gas rate adjusting motor is replaceable in situ.

1. Remove the batteries from the receiver unit to prevent the risk of short circuit.
2. Remove the two motor connection tags from the valve.
3. Remove the valve cover securing screw.
4. Unclip the valve cover from the valve on the right hand side by inserting a very small screwdriver in the slot on the right hand front of the cover and pull out the cover.
5. Turn the gas rate adjusting knob fully anticlockwise and gently manipulate the motor free from the valve (see note).
6. Replace with new motor ensuring that the motor is hooked into the right hand lug.
7. Replace the cover and secure with the screw.
8. Remake the motor connections ensuring that the large tag is fitted to the large spade (top connection) and vice versa.
9. Replace the batteries ensuring the correct polarity.
10. Operate the handset to check the operation of the motor.

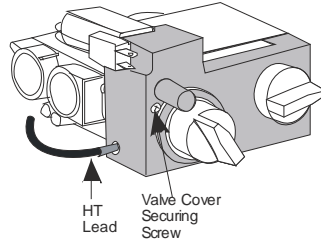

Figure 43

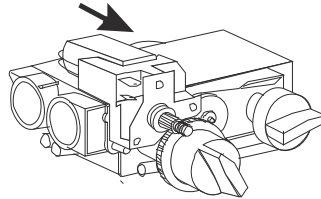

Figure 44

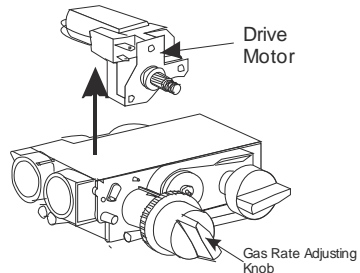

Figure 45



Note: Operating the gas rate adjusting knob manually will cause the motor clutch to operate. This is normal and will not affect the valves' operation.

4.2.6. **Replacing the Receiver (Total Control)**

1. Pull out the receiver from under the fire and remove the batteries.
2. Gently pull out the HT lead and the valve cable from the receiver (see **Figure 41**).
3. Unscrew and remove the SW and TC connections.
4. Refit in reverse order. (The valve cable plug fits into the receiver in one way only).
5. Replace the batteries and return the receiver under the heat shield.

4.2.7. **Programming Handset to Receiver (Total Control)**

If for some reason the remote handset requires re-programming to operate the receiver follow the procedure below:

1. Press and hold, using a pointed object, the receiver's reset button until you hear two acoustic signals (see **Figure 46**).
2. After the second longer acoustic signal, release the reset button and within the subsequent 20 seconds, press the  (small flame) on the remote handset until you hear an additional long acoustic signal confirming the new code is set.

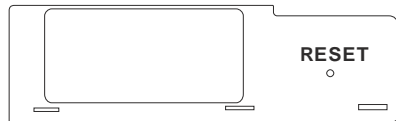

Figure 46

4.3. Installation and Operational Troubleshooting

The table below is intended for problems related to the fire and its gas controls. It is a guide only and does not take into account every eventuality. Servicing must be carried out in accordance with the current Gas Safety (Installation and Use) Regulations, by a competent person.

It is recommended that the purchaser seek the advice of the original installer in case of encountering any problems.

Symptom	Cause	Remedy
No spark appears at the electrode	a) Electrode cracked or broken	Replace electrode
	b) HT lead shorting out on burner body	Establish where spark is occurring and insulate or re-route lead accordingly.
	c) Faulty spark generator	Replace valve (Manual and Remote Control Models)
Piezo operates normally but pilot will not light	a) No gas supply	Check isolation valve/supply
	b) Pilot jet blocked	Replace pilot jet
Pilot lights, but goes out when control is released	a) Loose thermocouple connection at control valve end	Remake thermocouple ensuring the connection is firm
	b) Faulty Thermocouple	Replace thermocouple
	c) Cold Day / High Winds	Attempt to relight the pilot
Pilot and main burner go out when control is set to high position	a) Gas supply partially blocked	Locate restriction and remove faulty section
	b) Too many bends on gas inlet pipe	Increase diameter and/or reduce the number of bends
	c) Pilot jet partially blocked	Clean pilot jet.
	d) Restriction at Isolation valve	Ensure valve is fully open and that internal diameter is sufficient and free from grease



Warning: If you are in any doubt about the clearance of fumes, you must stop using the appliance immediately and seek expert advice. Do not use appliance until the fault has been rectified.

Remote Control, Total Control Models

Symptom	Cause	Remedy
Main burner will not come on when required even though the drive motor is heard to be operating	Ignition knob incorrectly set	Set the ignition knob at the 9 o'clock position.
Motor not functioning when buttons are pressed	a) Flat hand set battery (Remote Control)	Replace battery (1 X PP3)
	b) Flat batteries in receiver unit (Remote Control)	Replace all 4 AA batteries
	c) Flat batteries in battery holder (Trim Switch and Optimum Control)	Replace all 4 AA batteries
Remote Control will turn fire off but will not turn on	Incorrect hand set operation	Ensure two buttons are pressed to turn on
A prolonged audible signal is heard when attempting to light the fire with the remote handset (Total Control Model only).	ON/OFF switch on control valve in OFF position.	Turn the switch to ON position



NOTE: For any spare parts that are required, please contact either your supplier or the manufacturer directly. You will need the model name i.e. Model Number, the gas type, the type of control and serial number.

Only approved parts should be used.

This page is intentionally blank

This page is intentionally blank



Burley Magiglo fires are protected by
UK patents 2193802, 2240620 and 2256920
Other Patents Pending

Magiglo is a registered trademark of Burley Appliances Ltd.



Burley Appliances Ltd, Lands' End Way,
Oakham, Rutland, LE15 6RB

Tel: 01572 725570 Fax: 01572 724390
www.magiglo.co.uk Email: info@magiglo.co.uk